

Zaptec Sense → Installation Guide



We know that houses and apartment buildings have limited power. This is why we created Zaptec Sense. It helps you utilise your power in the smartest possible way, while also protecting your circuit breakers. Charge as many electric vehicles as possible, as quickly as possible using the power available.

English	3
Norsk	15
Svenska	25
Nederlands	35
Deutsch	45
Française	55

Included in the package

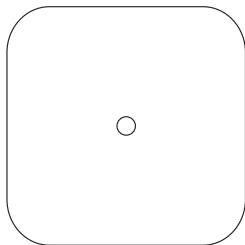
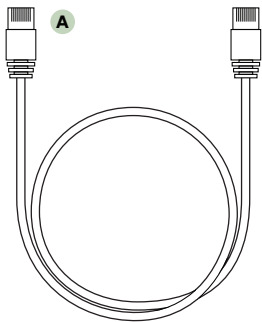

1 x Zaptec Sense

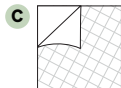
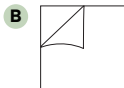

- A** Communication cable
- B** Adhesive magnet sheet for mounting
- C** Double-sided tape

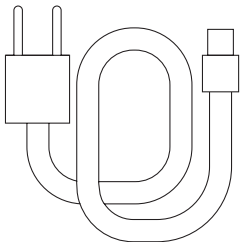

Zaptec Sense HAN only

Some energy meters, e.g. Kamstrup, need an external power supply. Regular phone charger 5VDC with Micro USB-B connector can be used.



If Zaptec Sense loses internet connectivity or is disconnected, the charging station will be set to provide minimum power (6A). This can be changed in the Zaptec portal.

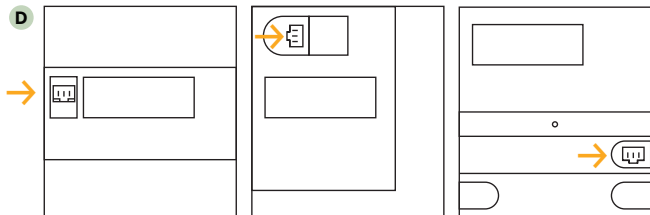

! The HAN/P1 port on your **D** energy meter is deactivated by default. Please contact your electricity provider to activate it. Zaptec Sense can be installed when your electricity provider has confirmed that your HAN/P1 port is open.

! Zaptec Sense is designed for indoor use.

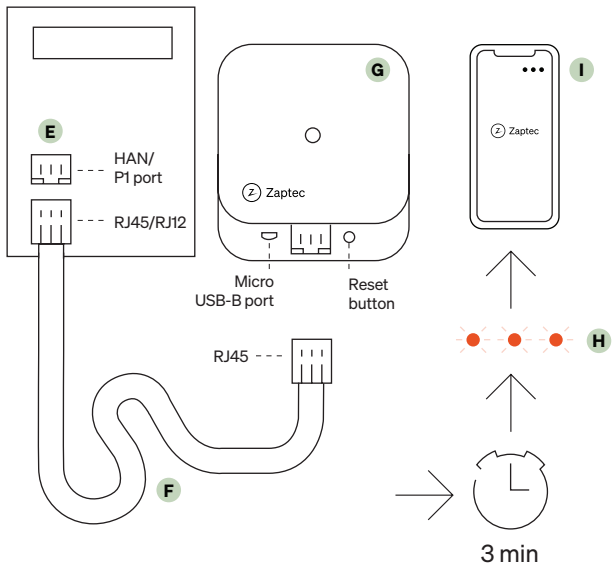

Installation

1. Plug Zaptec Sense **G** into the energy meter's HAN/P1 port **E** with the included cable **F** and wait for at least 3 minutes while the device is booting. Move to the next step when Zaptec Sense starts blinking orange. **H**
2. Download the **Zaptec app** from App Store or Google Play. Create an account or log in.
3. To install Zaptec Sense, tap the three dots **I** in the upper right corner of the Dashboard screen and select **Install Product**.
4. Scan the QR-code on the back of Zaptec Sense or this manual. Follow the on-screen instructions.
5. Once the light indicator on Zaptec Sense changes to continuous white, the installation is complete.

Configuration

If you need to change network settings after installation, hold your phone near Zaptec Sense, open the Zaptec app and tap the three dots to configure Zaptec Sense.

Light indicator



Not configured. No internet connection.
Log in via the **Zaptec app** and set up
a Wi-Fi network.



No M-Bus (HAN/P1 port) data received.
Check if the HAN/P1 port has been
opened by your utility company.



No IP received for Wi-Fi.



IP received, but no contact
with the cloud.



Zaptec Sense is configured and active.

Guarantee

Your Zaptec product comes with a five (5) year guarantee at no additional cost. Please find the guarantee document at **zaptec.com/guarantee**

Technical specifications

Mechanical and installation

Parameter	Description	Min	Typ	Max	Unit
Dimensions	H: W: D:			58.4 58.6 25.1	mm
Weight	Including: communication cable			70	g
Altitude				2000	m
Input cable	Micro USB-B cable (additional power supply)			3	m
	Zaptec Sense HAN: unshielded CAT6 cable Zaptec Sense P1: custom RJ45-RJ12 cable		1	3	m

Zaptec Sense is designed for indoor use.

General

Parameter	Description	Min	Typ	Max	Unit
Rated voltage	Micro USB-B port	4.5	5	5.5	VDC
Rated voltage	RJ45 HAN/P1 port	12/4.9		42/5.5	VDC
Rated current	Micro USB-B port			250	mA
Rated current	RJ45 HAN/P1 port	6/60		30/250	mA
Standby power consumption				1	W
Ambient operating temperature		-30		40	°C

Connectivity

Protocol	Supported Standards
Wi-Fi	IEEE 802.11b/g/n (2.4 GHz)
Bluetooth	Bluetooth V4.2 (BLE)
M-Bus (HAN)	2.4 kb/s
M-Bus (P1)	115.2 kb/s

Inkludert i pakken

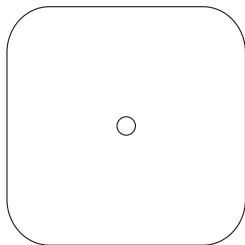
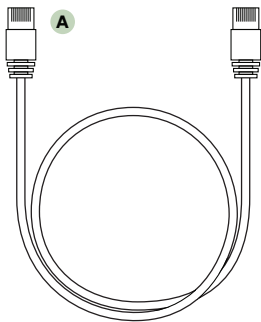

1 x Zaptec Sense

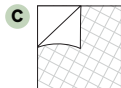
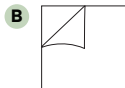

- A** Kommunikasjonskabel
- B** Selvklebende magnetark til montering
- C** Dobbeltsidig tape

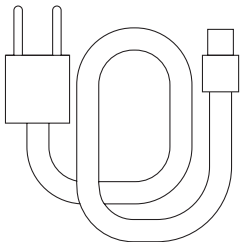

Kun til Zaptec Sense HAN

Enkelte strømmålere (for eksempel Kamstrup) må tilkobles en ekstern strømforsyning. Du kan da bruke en vanlig 5V-telefonlader med Micro-USB-B-inngang.



Hvis Zaptec Sense mister internettilkoblingen eller blir frakoblet, blir ladestasjonen satt til laveste ladestrøm (6A). Dette kan endres i Zaptec-portalen.

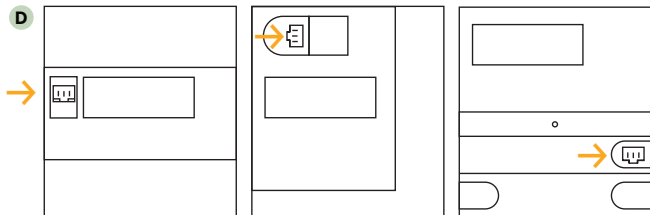

! HAN/P1-porten på **D** strømmåleren er deaktivert som standard. Ta kontakt med nettselskapet ditt for å få den aktivert. Zaptec Sense kan installeres når nettselskapet har bekreftet at HAN/P1-porten er åpnet.

! Zaptec Sense er laget for å brukes innendørs.

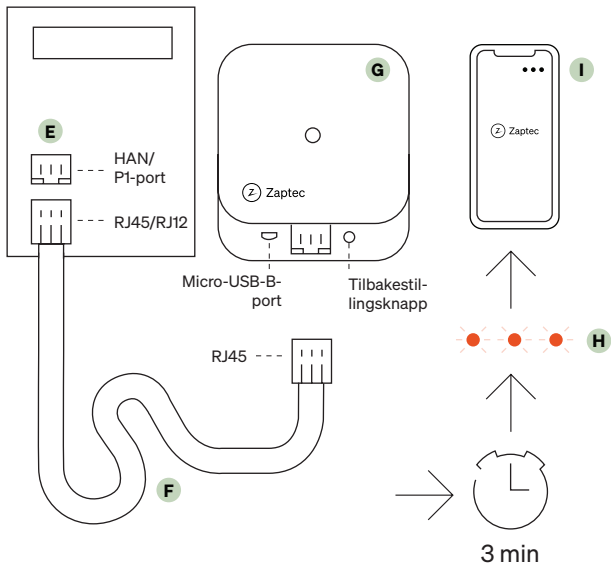

Installasjon

1. Plugg Zaptec Sense **G** inn i HAN/P1-porten på strøm-måleren **E** med den medfølgende kabelen, **F** og vent i minst 3 minutter mens enheten starter opp. Gå videre til neste trinn når Zaptec Sense begynner å blinke oransje. **H**
2. Last ned **Zaptec-appen** fra App Store eller Google Play. Opprett en konto eller logg inn.
3. Installer Zaptec Sense ved å trykke på de tre prikkene **I** øverst til høyre på dashbordet og velg **Installer produkt**.
4. Skann QR-koden på baksiden av Zaptec Sense eller denne veiledningen. Følg instruksjonene på skjermen.
5. Når indikatoren på Zaptec Sense lyser konstant hvitt, er installasjonen fullført.

Konfigurasjon

Hvis du vil gjøre endringer i nettverksinnstillingene etter installasjonen, holder du mobiltelefonen i nærheten av Zaptec Sense-enheten, åpner Zaptec-appen og trykker på de tre prikkene for å konfigurere Zaptec Sense.

Lysindikator



Ikke konfigurert. Ingen internettfordbinnelse. Logg inn via **Zaptec-appen** og sett opp et wifi-nettverk.



Ingen data for M-buss (HAN/P1-port). Sjekk med ditt nettselskap at HAN/P1-porten er åpent.



Ingen IP mottatt for wifi.



IP er mottatt, men det er ikke kontakt med skyen.



Zaptec Sense er konfigurert og aktiv.

Garanti

Zaptec-produktet leveres med fem (5) års garanti uten ekstra kostnad. Du finner garantidokumentet på **zaptec.com/guarantee**.

Tekniske spesifikasjoner

Mekanisk og installasjon

Parameter	Beskrivelse	Min.	Type	Maks.	Enhet
Mål	H: B: D:			58,4 58,6 25,1	mm
Vekt	Inkl. : kommunikasjonskabel			70	g
M.o.h.				2000	m
Inngangskabel	Micro-USB-B-kabel (ekstra strømforsyning)			3	m
	Zaptec Sense HAN: uskjernet CAT6-kabel Zaptec Sense P1: tilpasset RJ45-RJ12-kabel		1	3	m

Zaptec Sense er laget for å brukes innendørs.

Generelt

Parameter	Beskrivelse	Min.	Type	Maks.	Enhet
Merkespenning	Micro-USB-B-port	4,5	5	5,5	VDC
Merkespenning	RJ45 HAN/P1-port	12/4,9		42/5,5	VDC
Merkestrøm	Micro-USB-B-port			250	mA
Merkestrøm	RJ45 HAN/P1-port	6/60		30/250	mA
Strømforbruk i standby				1	W
Omgivelsestemperatur		-30		40	°C

Tilkobling

Protokoll	Støttede standarder
Wifi	IEEE 802.11b/g/n (2,4 GHz)
Bluetooth	Bluetooth V4.2 (BLE)
M-buss (HAN)	2,4 kb/s
M-Buss (P1)	115,2 kb/s

Ingår i paketet

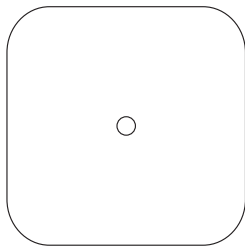
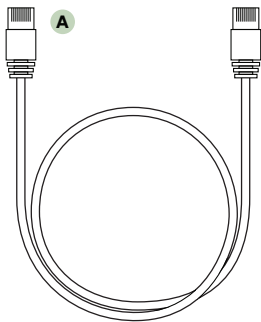

1 x Zaptec Sense

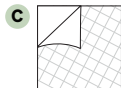
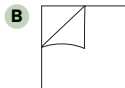

- A** Kommunikationskabel
- B** Självhäftande magnetisk plåt för montering
- C** Dubbelhäftande tejp

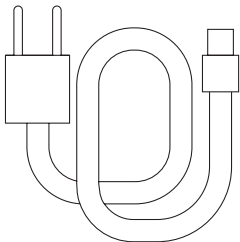

Endast Zaptec Sense HAN

Vissa energimätare, t.ex. Kamstrup, kräver extern strömförsörjning. Vanlig mobilladdare 5VDC med Micro USB-B-kontakt kan användas.



Om Zaptec Sense förlorar internetanslutningen eller kopplas från ställs laddstationen in på att leverera lägsta effekt (6A). Detta kan ändras i Zaptec-portalen.

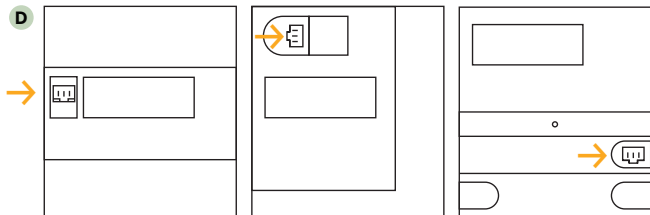

! HAN/P1-porten på din **D** energimätare är inaktiverad som standard. Kontakta din elleverantör för att aktivera den. Zaptec Sense kan installeras när din elleverantör har bekräftat att din HAN/P1-port är öppen.

! Zaptec Sense är konstruerad för placering väderskyddat.

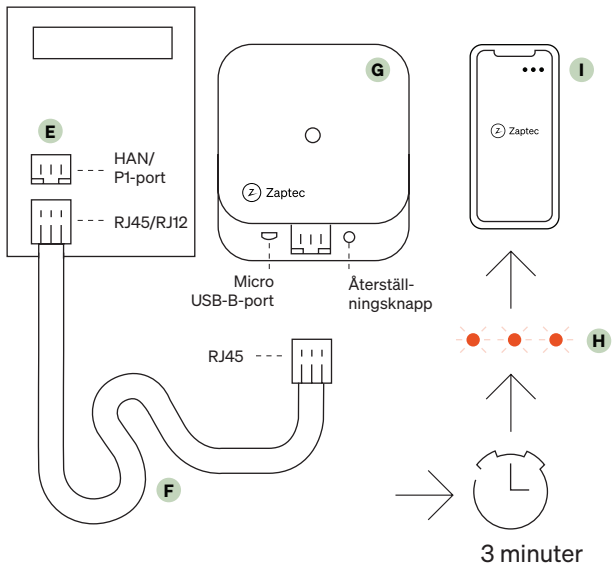

Installation

1. Anslut Zaptec Sense **G** till energimätarens HAN/P1-port **E** med hjälp av den medföljande kabeln **F** och vänta minst 3 minuter medan enheten startar upp. Gå till nästa steg när Zaptec Sense börjar blinka orange. **H**
2. Ladda ner **Zaptec-appen** från App Store eller Google Play. Skapa ett konto eller logga in.
3. För att installera Zaptec Sense, trycker du på de tre punkterna **I** i det övre högra hörnet på instrumentpanelen och väljer **Installera produkt**.
4. Skanna QR-koden på baksidan av Zaptec Sense eller denna manual. Följ instruktionerna på skärmen.
5. När indikatorlampan på Zaptec Sense lyser med ett fast vitt sken, är installationen slutförd.

Konfiguration

Om du behöver ändra nätverksinställningarna efter installationen håller du din mobiltelefon nära Zaptec Sense, öppnar Zaptec-appen och trycker på de tre punkterna för att konfigurera Zaptec Sense.

Indikatorlampa



Ej konfigurerad. Ingen internetanslutning. Logga in via **Zaptec-appen** och konfigurera ett wifinätverk.



Inga M-busdata (HAN/P1-port) har mottagits. Kontrollera om HAN/P1-porten har öppnats av ditt elbolag.



Wifinätverket har inte tilldelats någon IP-adress.



IP-adress mottagen, men ingen kontakt med molnet.



Zaptec Sense är konfigurerad och aktiv.

Garanti

Din Zaptec-produkt omfattas av fem (5) års garanti utan extra kostnad. Du hittar garantidokumentet på **zaptec.com/guarantee**.

Tekniska specifikationer

Mekaniskt och installation

Parameter	Beskrivning	Min	Typ	Max	Enhet
Dimensioner	H: B: D:			58,4 58,6 25,1	mm
Vikt	Inklusive: kommunikationskabel			70	g
Höjdnivå				2 000	m
Ingångskabel	Micro USB-B-kabel (ytterligare strömförsörjning)			3	m
	Zaptec Sense HAN: oskärmad CAT6-kabel Zaptec Sense P1: anpassad RJ45-RJ12-kabel		1	3	m

Zaptec Sense är konstruerad för placering väderskyddat.

Allmänt

Parameter	Beskrivning	Min	Typ	Max	Enhet
Märkspänning	Micro USB-B-port	4,5	5	5,5	VDC
Märkspänning	RJ45 HAN/P1-port	12/4,9		42/5,5	VDC
Märkström	Micro USB-B-port			250	mA
Märkström	RJ45 HAN/P1-port	6/60		30/250	mA
Standby förbrukning				1	W
Temperaturområde		-30		40	°C

Kommunikationsgränssnitt

Protokoll	Standarder som stöds
Wi-Fi	IEEE 802.11b/g/n (2,4 GHz)
Bluetooth	Bluetooth V4.2 (BLE)
M-bus (HAN)	2,4 kb/s
M-bus (P1)	115,2 kb/s

Inbegrepen in het pakket

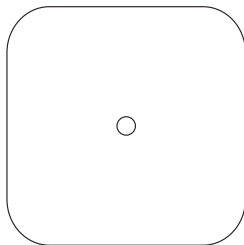
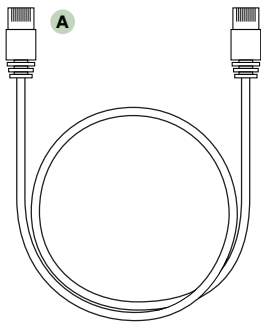

1 x Zaptec Sense

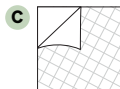
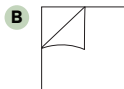

- A** Communicatiekabel
- B** Zelfklevend magneetvel voor montage
- C** Dubbelzijdig tape

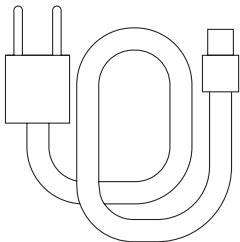



Alleen bij de Zaptec Sense HAN

Sommige energiemeters, zoals Kamstrup, hebben een externe voeding nodig. Er kan een normale telefoonoplader van 5VDC met Micro USB-B-aansluiting worden gebruikt.

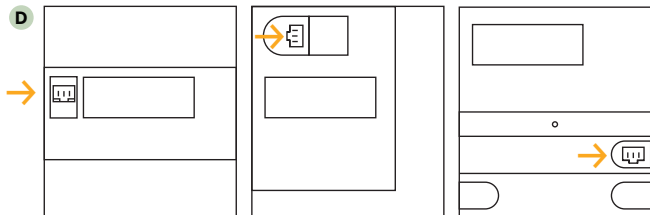

Als Zaptec Sense de internetverbinding verliest of de verbinding wordt verbroken, wordt het laadstation ingesteld om minimaal vermogen (6A) te leveren. Dit kan worden gewijzigd in het Zaptec-portaal.



-  De HAN/P1-poort op uw **D** energiemeter is standaard gedeactiveerd. Neem contact op met uw energieleverancier of netbeheerder om deze te activeren. De Zaptec Sense kan worden geïnstalleerd wanneer uw energieleverancier of netbeheerder heeft bevestigd dat uw HAN/P1-poort open is.
-  Zaptec Sense is ontworpen voor gebruik binnenshuis.

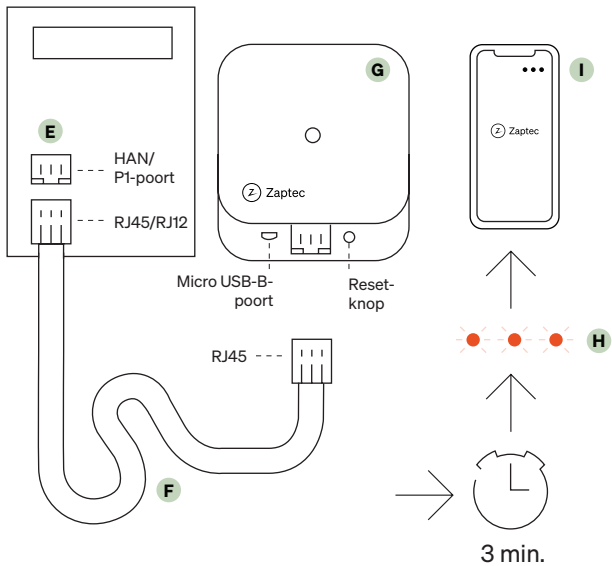

Installatie

1. Steek de Zaptec Sense **G** in de HAN/P1-poort van de energiemeter **E** met de meegeleverde kabel **F** en wacht ten minste 3 minuten terwijl het apparaat is opgestart. Ga naar de volgende stap wanneer de Zaptec Sense oranje begint te knipperen. **H**
2. Download de **Zaptec app** in de App Store of in Google Play. Maak een account aan of log in.
3. Om de Zaptec Sense te installeren, tikt u op de drie stippen **I** in de rechterbovenhoek onder Dashboard en selecteert u **Product installeren**.
4. Scan de QR-code op de achterkant van Zaptec Sense of op deze handleiding. Volg de instructies op het scherm.
5. Zodra het lampje op de Zaptec Sense verandert en continu wit brandt, is de installatie voltooid.

Configuratie

Om de netwerkinstellingen na de installatie aan te passen, houdt u uw mobiele telefoon in de buurt van de Zaptec Sense, open de Zaptec-app en druk op de drie stippen om Zaptec Sense te configureren.

Lichtindicator



Niet geconfigureerd. Geen internetverbinding. Log in via de **Zaptec app** en stel een wifi-netwerk in.



Geen M-bus (HAN/P1-poort) gegevens ontvangen. Controleer of de HAN/P1-poort is geopend door uw nutsbedrijf.



Geen IP ontvangen voor wifi.



IP ontvangen, maar geen contact met de cloud.



Zaptec Sense is geconfigureerd en actief.

Garantie

Uw Zaptec-product wordt geleverd met een garantie van vijf (5) jaar zonder extra kosten. Het garantiedocument is te vinden op **zaptec.com/guarantee**.

Technische specificaties

Mechanisch en installatie

Parameter	Beschrijving	Min.	Type	Max.	Eenheid
Afmetingen	H: B: D:			58,4 58,6 25,1	mm
Gewicht	Inclusief: communicatiekabel			70	g
Hoogte				2000	m
Ingangskabel	Micro USB-B-kabel (extra voeding)			3	m
	Zaptec Sense HAN: niet-af- geschermdde CAT6-kabel		1	3	m
	Zaptec Sense P1: aangepaste RJ45-RJ12-kabel				

Zaptec Sense is ontworpen voor gebruik binnenshuis.

Algemeen

Parameter	Beschrijving	Min.	Type	Max.	Eenheid
Nominale spanning	Micro USB-B-poort	4,5	5	5,5	VDC
Nominale spanning	RJ45 HAN/P1-poort	12/4,9		42/5,5	VDC
Nominale stroom	Micro USB-B-poort			250	mA
Nominale stroom	RJ45 HAN/P1-poort	6/60		30/250	mA
Stroomverbruik in stand-by				1	W
Omgevingstemperatuur		-30		40	°C

Connectiviteit

Protocol	Ondersteunde standaarden
Wifi	IEEE 802.11b/g/n (2,4 GHz)
Bluetooth	Bluetooth V4.2 (BLE)
M-bus (HAN)	2,4 kb/s
M-bus (P1)	115,2 kb/s

Im Lieferumfang enthalten

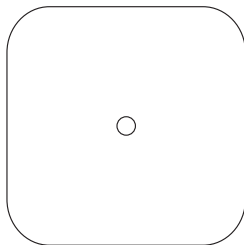
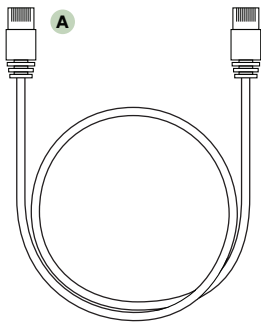

1 Zaptec Sense

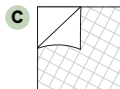
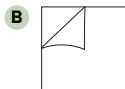

- A** Kommunikationskabel
- B** Selbstklebende Magnetfolie zur Montage
- C** Doppelseitiges Klebeband

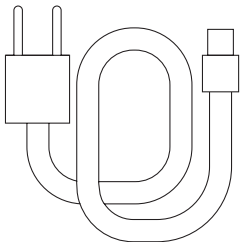

Nur Zaptec Sense HAN

Einige Energiezähler, zum Beispiel Kamstrup, benötigen eine externe Stromversorgung. Hierfür kann z.B. ein Telefon Ladekabel mit 5VDC und Micro-USB-B-Anschluss verwendet werden.



Für den Fall, dass Zaptec Sense die Internetverbindung verliert oder getrennt wird, ist die Ladestation so eingestellt, dass sie eine Mindestleistung (6A) bereitstellt. Dies kann im Zaptec Portal geändert werden.

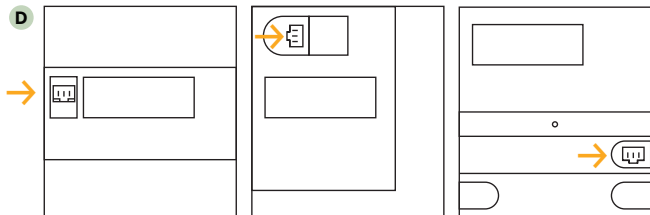

- ! Standardmäßig ist der HAN/P1-Anschluss des **D** Energiezählers deaktiviert. Lassen Sie ihn von Ihrem Stromanbieter aktivieren. Zaptec Sense kann installiert werden, wenn der Stromanbieter bestätigt, dass der HAN/P1-Anschluss freigegeben ist.
- ! Zaptec Sense ist für die Verwendung im Innenbereich vorgesehen.

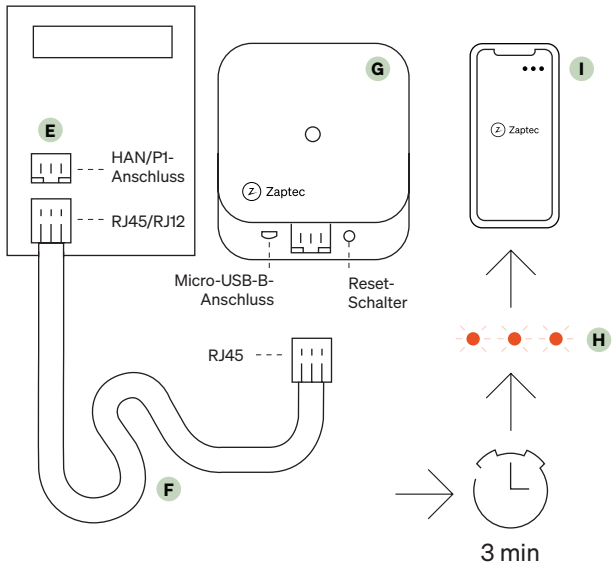

Installation

1. Schließen Sie Zaptec Sense **G** mit dem mitgelieferten Kabel **F** an den HAN/P1-Anschluss des Energiezählers **E** an, und warten Sie mindestens 3 Minuten, während das Gerät hochfährt. Gehen Sie zum nächsten Schritt über, wenn Zaptec Sense orange zu blinken beginnt. **H**
2. Laden Sie die **Zaptec App** im App Store / Google Play herunter. Erstellen Sie ein Konto, oder melden Sie sich an.
3. Für die Installation von Zaptec Sense tippen Sie auf die drei Punkte **I** rechts oben im Dashboard, und wählen Sie **Produkt installieren** aus.
4. Scannen Sie den QR-Code auf der Rückseite von Zaptec Sense oder in diesem Handbuch. Befolgen Sie die Anweisungen auf dem Bildschirm.
5. Sobald die Kontrolllampe von Zaptec Sense dauerhaft weiß leuchtet, ist die Installation abgeschlossen.

Konfiguration

Zum Anpassen der Netzwerkeinstellungen nach der Installation halten Sie Ihr Smartphone in die Nähe von Zaptec Sense. Rufen Sie die Zaptec App auf, und tippen Sie zum Konfigurieren von Zaptec Sense auf die drei Punkte.

Kontrolllampe



Nicht konfiguriert. Keine Internetverbindung. Melden Sie sich über die **Zaptec App** an, und richten Sie ein WLAN ein.



Keine M-Bus (HAN/P1-Port) Daten empfangen. Überprüfen Sie, ob der HAN/P1-Port von Ihrem Energieversorger freigeschaltet wurde.



Keine IP für WLAN empfangen.



IP empfangen, aber kein Kontakt zur Cloud.



Zaptec Sense ist konfiguriert und aktiv.

Garantie

Ihr Zaptec Produkt wird mit einer fünfjährigen Garantie ohne zusätzliche Kosten geliefert. Bitte finden Sie das Garantiedokument unter **zaptec.com/guarantee**.

Technische Daten

Mechanik und Installation

Parameter	Beschreibung	Min.	Typ	Max.	Einheit
Abmessungen	H: B: T:			58,4 58,6 25,1	mm
Gewicht	Inkl. Kommunikationskabel			70	g
Höhe				2000	m
Zuleitung	Micro-USB-B Kabel (zusätzliche Stromversorgung)			3	m
	Zaptec Sense HAN: nicht abgeschirmtes CAT6-Kabel Zaptec Sense P1: kundenspezifisches RJ45-RJ12-Kabel		1	3	m

Zaptec Sense ist für die Verwendung im Innenbereich vorgesehen.

Allgemeines

Parameter	Beschreibung	Min.	Typ	Max.	Einheit
Nennspannung	Micro-USB-B-Anschluss	4,5	5	5,5	VDC
Nennspannung	RJ45 HAN/P1-Anschluss	12/4,9		42/5,5	VDC
Nennstrom	Micro-USB-B-Anschluss			250	mA
Nennstrom	RJ45 HAN/P1-Anschluss	6/60		30/250	mA
Energieverbrauch im Standby				1	W
Umgebungstemperatur		-30		40	°C

Konnektivität

Protokoll	Unterstützte Normen
WLAN	IEEE 802.11b/g/n (2,4 GHz)
Bluetooth	Bluetooth V4.2 (BLE)
M-Bus (HAN)	2,4 kb/s
M-Bus (P1)	115,2 kb/s

Inclus dans le forfait

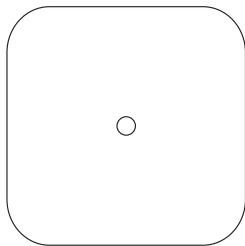
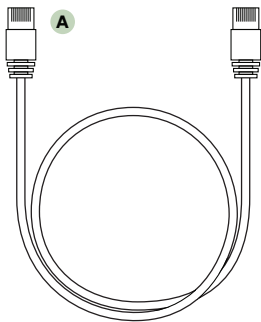

1 x Zaptac Sense

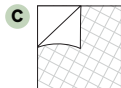
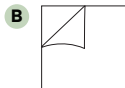

- A** Câble de communication
- B** Feuille aimantée adhésive pour montage
- C** Ruban adhésif double face

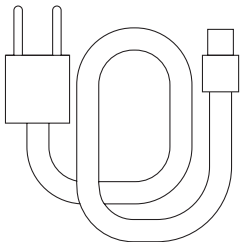

Zaptec Sense HAN uniquement

Certains compteurs d'énergie, par exemple Kamstrup, ont besoin d'une alimentation externe. Un chargeur de téléphone standard 5VDC avec connecteur Micro USB-B peut être utilisé.



Si Zaptec Sense perd sa connectivité Internet ou est déconnecté, la station de charge sera réglée pour assurer une puissance minimale (6A). Cela peut être modifié dans le portail Zaptec.

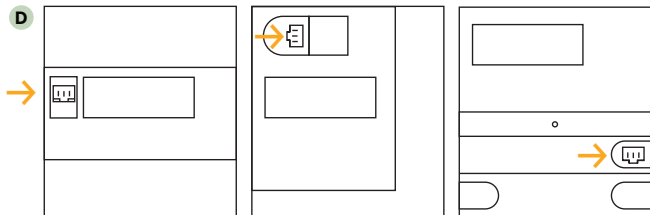

Le port HAN/P1 de votre **D** compteur d'énergie est désactivé par défaut. Veuillez contacter votre fournisseur d'électricité pour l'activer. Zaptec Sense peut être installé lorsque votre fournisseur d'électricité a confirmé que votre port HAN/P1 est ouvert.



Zaptec Sense est conçu pour une utilisation en intérieur.

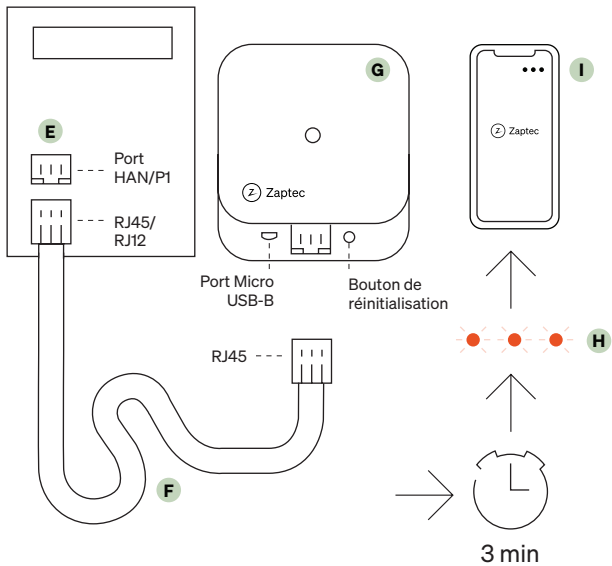

Installation

1. Branchez Zaptec Sense **G** dans le port HAN/P1 du compteur d'énergie **E** avec le câble fourni **F** et attendez au moins 3 minutes pendant le démarrage de l'appareil. Passez à l'étape suivante lorsque Zaptec Sense commence à clignoter en orange. **H**
2. Téléchargez l'application Zaptec dans App Store/Google Play. Créez un compte ou connectez-vous.
3. Pour installer Zaptec Sense, appuyez sur les trois points **I** dans le coin supérieur droit de l'écran Tableau de bord et sélectionnez **Installer le produit**.
4. Scannez le code QR au dos de Zaptec Sense ou de ce manuel. Suivez les instructions à l'écran.
5. Une fois que l'indicateur lumineux sur Zaptec Sense passe au blanc continu, l'installation est terminée.

Configuration

Pour ajuster les paramètres réseau après l'installation, tenez votre téléphone près de l'appareil Zaptec Sense, ouvrez l'application Zaptec et appuyez sur les trois points pour configurer Zaptec Sense.

Indicateur lumineux



Non configuré. Pas de connexion Internet. Connectez-vous via **l'application Zaptec** et configurez un réseau Wi-Fi.



Aucune donnée M-Bus (port HAN/P1) reçue. Vérifiez si le port HAN/P1 a été ouvert par votre société de services publics.



Aucune adresse IP reçue pour le Wi-Fi.



IP reçue, mais pas de contact avec le cloud.



Zaptec Sense est configuré et actif.

Garantie

Votre produit Zaptec est livré avec une garantie de cinq (5) ans sans frais supplémentaires. Veuillez trouver le document de garantie à l'adresse **zaptec.com/guarantee**.

Caractéristiques techniques

Mécanique et installation

Paramètre	Description	Min.	Typ	Max.	Unité
Dimensions	H : L : P :			58,4 58,6 25,1	mm
Poids	Incluant : câble de communication			70	g
Altitude				2000	m
Câble d'entrée	Câble micro USB-B (alimentation supplémentaire)			3	m
	Zaptec Sense HAN : câble CAT6 non blindé Zaptec Sense P1 : câble RJ45-RJ12 personnalisé		1	3	m

Zaptec Sense est conçu pour une utilisation en intérieur.

Généralités

Paramètre	Description	Min.	Typ	Max.	Unité
Tension nominale	Port Micro USB-B	4,5	5	5,5	VDC
Tension nominale	Port RJ45 HAN/P1	12/4,9		42/5,5	VDC
Courant nominal	Port Micro USB-B			250	mA
Courant nominal	Port RJ45 HAN/P1	6/60		30/250	mA
Consommation en veille				1	W
Plages de température de fonctionnement		-30		40	°C

Connectivité

Protocole	Normes prises en charge
Wi-Fi	IEEE 802.11b/g/n (2,4 GHz)
Bluetooth	Bluetooth V4.2 (BLE)
M-Bus (HAN)	2,4 kb/s
M-Bus (P1)	115,2 kb/s

Zaptec Charger AS
Vassbotnen 1
4313 Sandnes
Norway

Made in Norway



zaptec.com

© Zaptec Charger AS 13.05.2024. All rights reserved. MA-00012-D1